

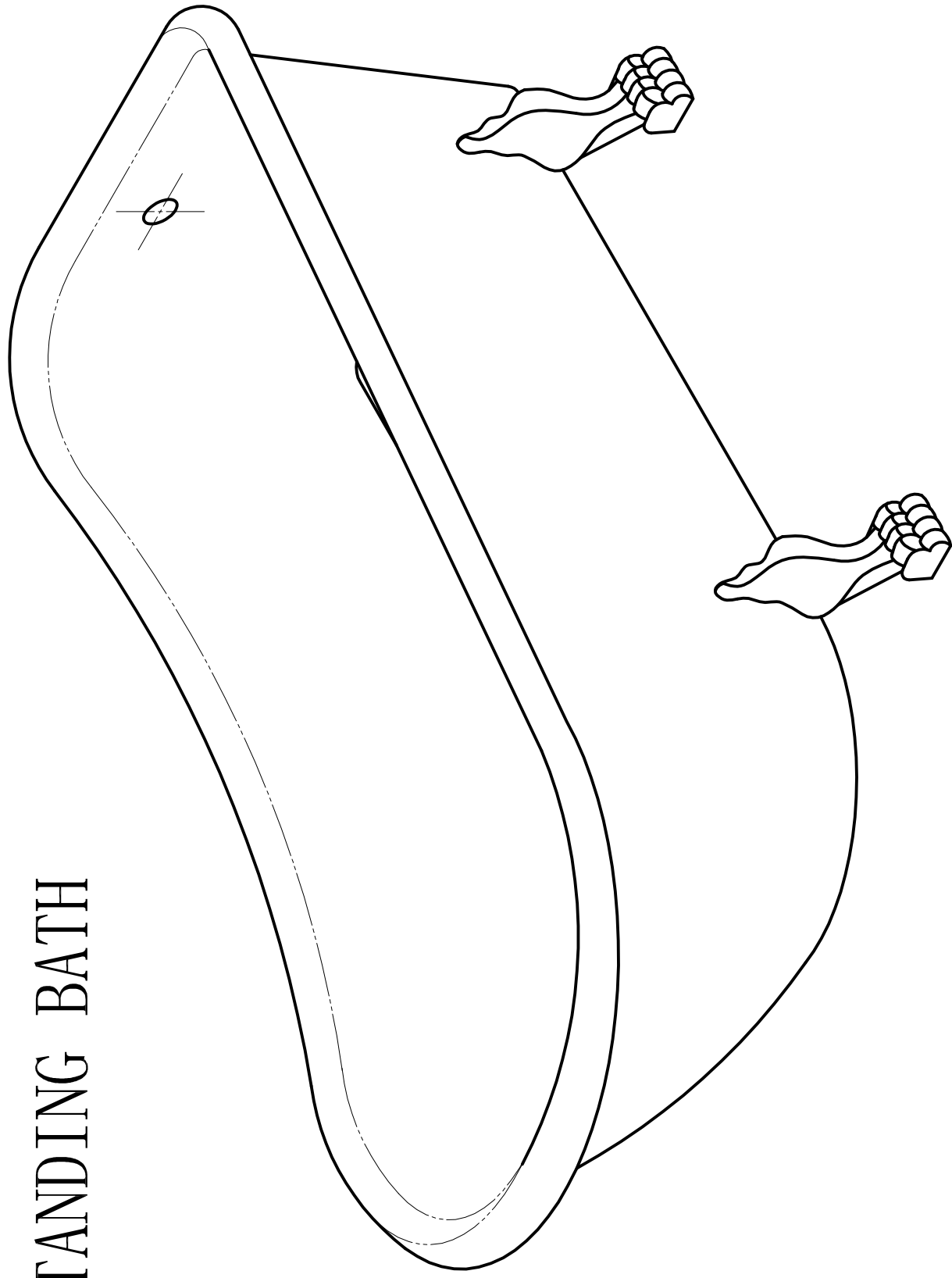

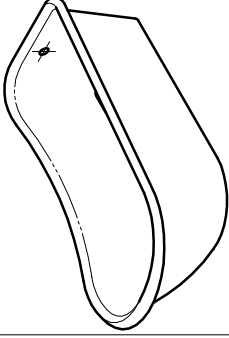

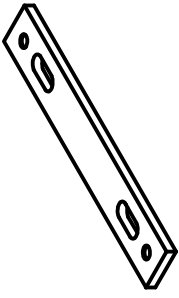



SLF17
LOANE SLIPPER
FREESTANDING BATH



No	Name	Photo	Qty
1	bathtub		1
2	steel panel		2
3	flat mat ø10		4
4	screw M10		4
5	claw foot		4
6	flat mat ø12		4
7	flexible mat		4
8	Bolt M12×25		4
9	Claw foot adjust		4

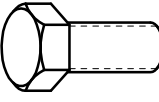
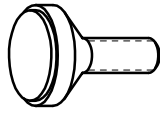
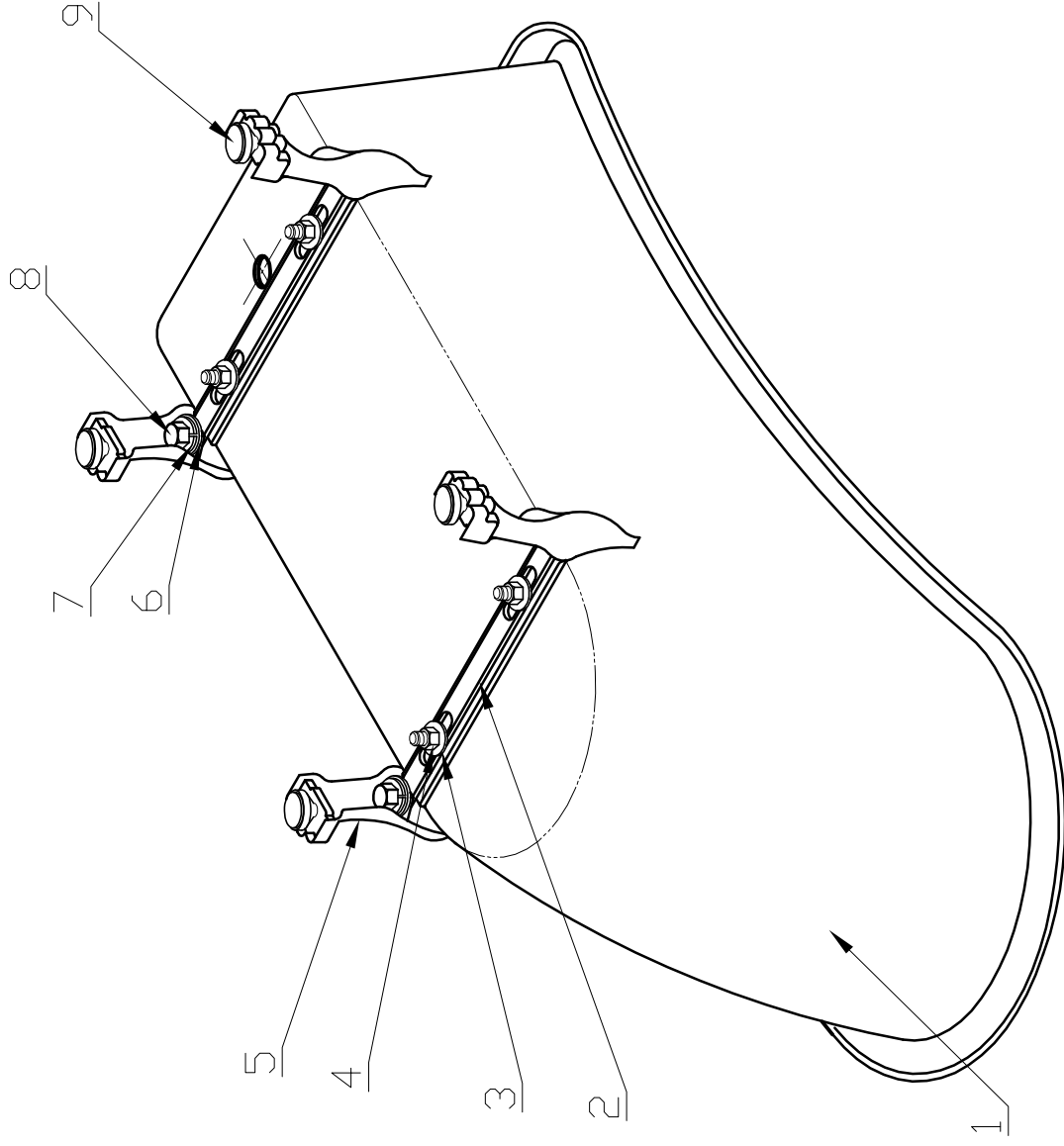

	tools required
A	
B	